



DELTA



- ↘ Delta 0 Simmetrico
- ↘ Delta 0 Asimmetrico
- ↘ Delta 0 Soft
- ↘ Delta 0 Arc
- ↘ Delta 1 Simmetrico
- ↘ Delta 1 Asimmetrico
- ↘ Delta 1 Circular
- ↘ Delta 2 Simmetrico
- ↘ Delta 2 Asimmetrico
- ↘ Delta 2 Circular
- ↘ Delta 3 Simmetrico
- ↘ Delta 3 Asimmetrico
- ↘ Delta 3 Circular

DELTA

NEW

The range



DELTA 0



DELTA 1



DELTA 2



DELTA 3

DELTA 0 NEW

Installazione

Installation
Installation
Instalación

Terra - Parete - Soffitto

Ground - Wall - Ceiling
Sol - Mur - Plafond
Suelo - Pared - Techo

Materiali

Materials
Materiali
Materiales

Materiale Corpo: Alluminio | Tipo di diffusore: Vetro | Trattamento: Bordo Mare

Material: Aluminium | Diffuser type: Glass | Treatment: Sea Treatment
Matériel du corps: Aluminium | Type de diffuseur: Verre | Traitement: Bord de Mer
Material del cuerpo: Aluminio | Tipo de difusor: Cristal | Tratamiento: Tratamiento marino

Alimentazione

Power supply
Alimentation
Alimentación

220-240 V

Versioni

Versions
Versions
Versiones

DALI



DELTA 0
SIMMETRICO



DELTA 0
ASIMMETRICO



DELTA 0
SOFT



DELTA 0
ARC



Scopri la gamma
Discover the range
Découvrez la gamme
Descubre la gama

COLOURS



White RAL 9010



Grey High Tech RAL 9006







Corten



Black RAL 9005

Delta 0 Simmetrico



IP66 IK 08 5J xx7 CE UK CB	LED			COL.	CODE *
	W	LM MAX.	REAL LM MAX.		
	16	2494	2319		LL15401WS1□
					LL15401GS1□
					LL15401KS1□
					LL15401BS1□
	16	2494	2319		LM15401WS1□
					LM15401GS1□
					LM15401KS1□
					LM15401BS1□
	27	4138	3848		LL15402WS1□
					LL15402GS1□
					LL15402KS1□
					LL15402BS1□
	27	4138	848		LM15402WS1□
					LM15402GS1□
					LM15402KS1□
					LM15402BS1□

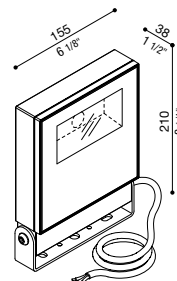





* Complete the CODE □ LED COLOUR 5 | 5700K N | 4000K 3 | 3000K 2 | 2700K 1 | 2200K

Fornito con cavo 0,7m H05RN-F. | Supplied with 0.7m H05RN-F cable. | Fourni avec un câble H05RN-F de 0,7 m. | Se suministra con cable H05RN-F de 0,7 m.

Delta 0 Asimmetrico



IP66 IK 08 5J xx7 CE UK CB	LED			COL.	CODE *
	W	LM MAX.	REAL LM MAX.		
	16	2494	2270		LL15401WA1□
					LL15401GA1□
					LL15401KA1□
					LL15401BA1□
	16	2494	2270		LM15401WA1□
					LM15401GA1□
					LM15401KA1□
					LM15401BA1□
	27	4138	3766		LL15402WA1□
					LL15402GA1□
					LL15402KA1□
					LL15402BA1□
	27	4138	3766		LM15402WA1□
					LM15402GA1□
					LM15402KA1□
					LM15402BA1□

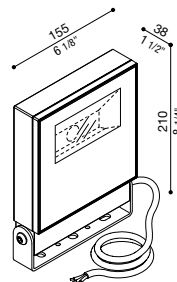

* Complete the CODE □ LED COLOUR 5 | 5700K N | 4000K 3 | 3000K 2 | 2700K 1 | 2200K

Fornito con cavo 0,7m H05RN-F. | Supplied with 0.7m H05RN-F cable. | Fourni avec un câble H05RN-F de 0,7 m. | Se suministra con cable H05RN-F de 0,7 m.

Delta 0 Soft



IP66 IK 08 5J xx7 CE UK E8	LED			COL.	CODE *
	W	LM	REAL LM		
	MAX.	MAX.			
	16	2494	1247		LL15401WSF□
					LL15401GSF□
					LL15401KSF□
					LL15401BSF□
	16	2494	1247		LM15401WSF□
					LM15401GSF□
					LM15401KSF□
					LM15401BSF□
	27	4138	2069		LL15402WSF□
					LL15402GSF□
					LL15402KSF□
					LL15402BSF□
	27	4138	2069		LM15402WSF□
					LM15402GSF□
					LM15402KSF□
					LM15402BSF□

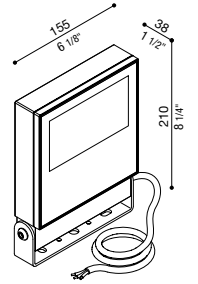

* Complete the CODE □ LED COLOUR 5 | 5700K N | 4000K 3 | 3000K 2 | 2700K 1 | 2200K

Fornito con cavo 0,7m H05RN-F. | Supplied with 0.7m H05RN-F cable. | Fourni avec un câble H05RN-F de 0,7 m. | Se suministra con cable H05RN-F de 0,7 m.

Delta 0 Arc



IP66 IK 08 5J xx7 CE UK E5	LED			COL.	CODE *
	W	LM MAX.	REAL LM MAX.		
	10	871	636	220-240 V	LL15403W□□
					LL15403G□□
					LL15403K□□
					LL15403B□□
	10	871	636	220-240 V DALI	LM15403W□□
					LM15403G□□
					LM15403K□□
					LM15403B□□
	19	1370	993	220-240 V	LL15404W□□
					LL15404G□□
					LL15404K□□
					LL15404B□□
	19	1370	993	220-240 V DALI	LM15404W□□
					LM15404G□□
					LM15404K□□
					LM15404B□□

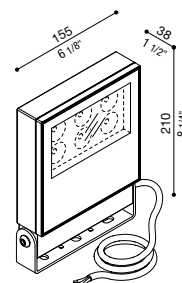

* Complete the CODE ○ OPTIC RS | 4° ME | 15° WI | 30° WW | 50° EP | 8° X 50° EV | 50° X 8° □ LED COLOUR N | 4000K 3 | 3000K 2 | 2700K 1 | 2200K

Fornito con cavo 0,7m H05RN-F. | Supplied with 0.7m H05RN-F cable. | Fourni avec un câble H05RN-F de 0,7 m. | Se suministra con cable H05RN-F de 0,7 m.



A richiesta, disponibili versioni con vetro colorato: rosso, verde, giallo e bianco.

On request, versions with colored glass available: red, green, yellow and white.

Sur demande, des versions avec verre coloré sont disponibles: rouge, vert, jaune et blanc.

Bajo pedido, versiones de cristal de colores: rojo, verde, amarillo y blanco.





Sbraccio Delta 0

Bracket Delta 0





Bras Delta 0

Brazo Delta 0

Sbraccio 300mm Delta 0

Col.	Code
	LB154004W
	LB154004G
	LB154004K
	LB154004B

Sbraccio 500mm Delta 0

Col.	Code
	LB154005W
	LB154005G
	LB154005K
	LB154005B

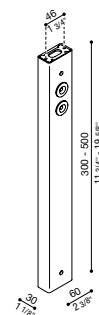

Ganascia Delta per palo Ø60mm

Non adatto per Delta 3. Non idoneo per installazione su palo Still.

Delta side adapter for post Ø60mm





Not suitable for Delta 3 and for installation on Still posts.

Adaptateur latéral Delta pour poteau Ø60mm

Ne convient pas pour Delta 3 et pour l'installation sur des poteaux Still.

Adaptador lateral Delta para poste Ø60 mm

No apto para Delta 3 ni para instalación en postes Still.

Col.	Code
	LB154000W
	LB154000G
	LB154000K
	LB154000B

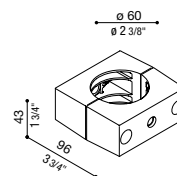

Accessorio giardino

Accessorio da giardino realizzato in materiale termoplastico. Adatto per uso esterno, idoneo per installazione a terra.

Garden accessory

Thermoplastic garden accessory. Suitable for outdoor use and ground application.

Accessoire de jardin

Accessoire de jardin en matériau thermoplastique. Également adapté à l'usage à l'extérieur. Convient pour une utilisation au sol.

Accesório para jardim

Accesorio de jardín de material termoplástico. Adecuado para el uso al exteriores. Idóneo para instalación en el suelo.

Col.	Code
	LB1150035

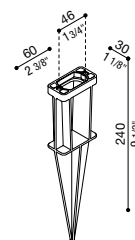

Connettore maschio/femmina 5 poli DALI

Accessorio IP66/IP68 per la connessione di due prodotti in serie DALI. Adatto per cavo ø7/13,5.

5-pin male/female connector DALI

Accessory IP66/IP68 for connecting two products in series DALI. Suitable for ø7/13,5 cable.

Connecteur mâle/femelle à 5 broches DALI

Accessoire IP66/IP68 pour connecter deux produits en série DALI. Convient pour un câble ø7/13,5.

Conector macho/hembra de 5 polos DALI

Accesorio IP66/IP68 para conectar dos productos en serie DALI. Adecuado para cable ø7/13,5.

Col.	Code
	LB156002

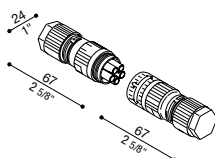

Morsettiera coassiale 3 poli

Morsettiera coassiale a 3 poli, IP68, per cavo ø 7/12 mm.

3-pole coaxial terminal block

3-pole coaxial terminal block, IP68, for cable ø 7/12 mm.

Bornier coaxial à 3 pôles

Bornier coaxial à 3 pôles, IP68, pour câble ø 7/12 mm.

Bloque de terminales coaxiales de 3 polos

Bloque de terminales coaxiales de 3 polos, IP68, para cable ø 7/12 mm.

Col.	Code
	LB11293

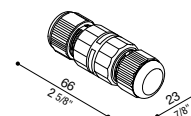



DELTA 0 ASIMMETRICO







FEATURES



Delta 0 con accessorio Sbraccio.

Delta 0 with Bracket accessory.

Delta 0 avec accessoire Bras.

Delta 0 con accesorio Brazo.



Colori disponibili.

Available colours.

Couleurs disponibles.

Colores disponibles.



FEATURES

Fasci luminosi
 Light beams
 Faisceaux lumineux
 Haces luminosas

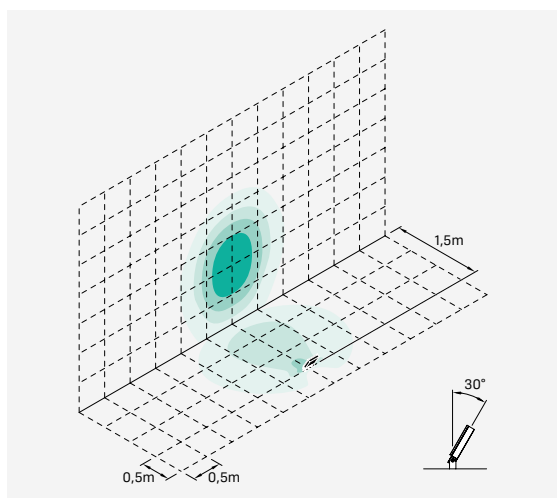
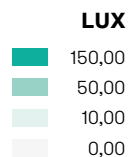

RS 4° DELTA 0 ARC 19W

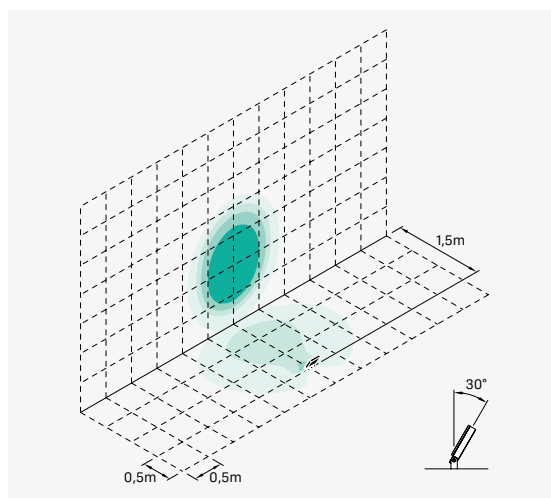

ME 15° DELTA 0 ARC 19W

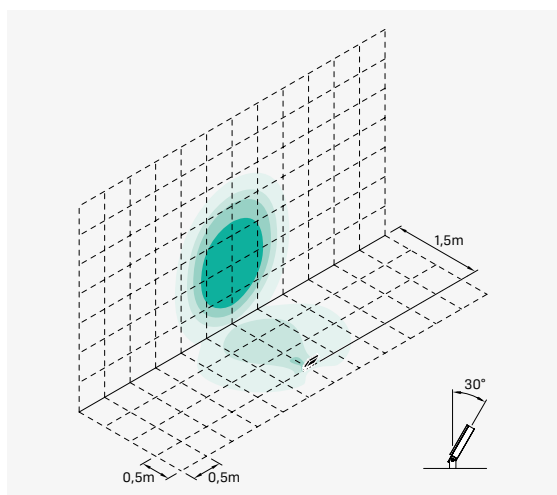

WI 30° DELTA 0 ARC 19W

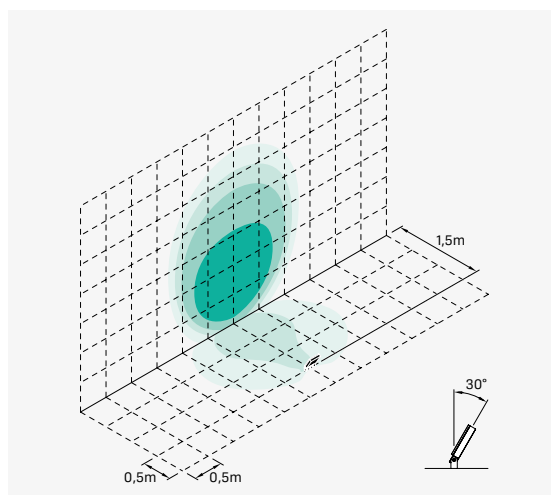

WW 50° DELTA 0 ARC 19W

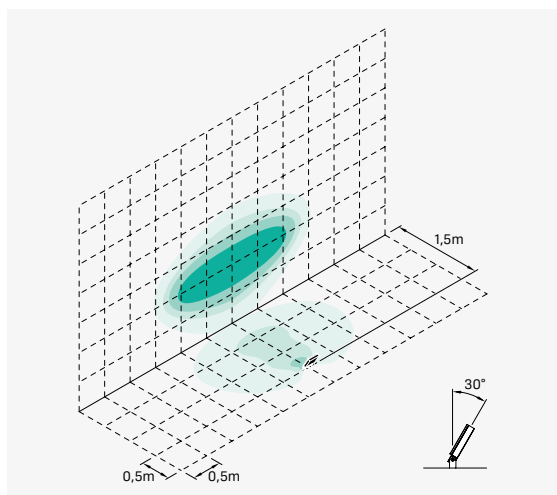

EP 8°X50° DELTA 0 ARC 19W

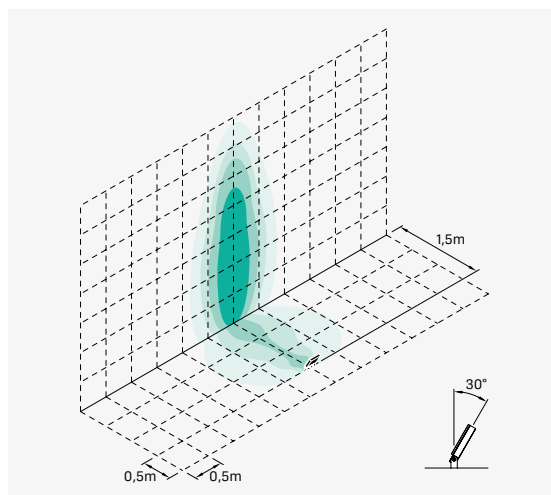

EV 50°X8° DELTA 0 ARC 19W

DELTA 1 NEW

Installazione

Installation
Installation
Instalación

Terra - Parete - Soffitto

Ground - Wall - Ceiling
Sol - Mur - Plafond
Suelo - Pared - Techo

Materiali

Materials
Materiali
Materiales

Materiale Corpo: Alluminio | Tipo di diffusore: Vetro | Trattamento: Bordo Mare

Material: Aluminium | Diffuser type: Glass | Treatment: Sea Treatment
Matériel du corps: Aluminium | Type de diffuseur: Verre | Traitement: Bord de Mer
Material del cuerpo: Aluminio | Tipo de difusor: Cristal | Tratamiento: Tratamiento marino

Alimentazione

Power supply
Alimentation
Alimentación

220-240 V

Versioni

Versions
Versions
Versiones

DALI - Sensore di movimento

DALI - Motion sensor
DALI - Détecteur
DALI - Motion sensor



DELTA 1
SIMMETRICO



DELTA 1
ASIMMETRICO



DELTA 1
CIRCULAR



Scopri la gamma
Discover the range
Découvrez la gamme
Descubre la gama

COLOURS



White RAL 9010



Grey High Tech RAL 9006



Corten



Black RAL 9005

Delta 1 Simmetrico



IP66 IK 08 5J xx7 CE UK	LED			COL.	CODE *
	W	LM	REAL LM		
	37	6237	5800	220-240 V	LL15411WS1□
					LL15411GS1□
					LL15411KS1□
					LL15411BS1□
	37	6237	5800	220-240 V DALI	LM15411WS1□
					LM15411GS1□
LM15411KS1□					
LM15411BS1□					
50	7489	6965	220-240 V	LL15412WS1□	
				LL15412GS1□	
				LL15412KS1□	
				LL15412BS1□	
50	7489	6965	220-240 V DALI	LM15412WS1□	
				LM15412GS1□	
				LM15412KS1□	
				LM15412BS1□	
17	3175	2953	220-240 V (☞)	LS15411WS1□	
				LS15411GS1□	
				LS15411KS1□	
				LS15411BS1□	
27	4372	4066	220-240 V (☞)	LS15412WS1□	
				LS15412GS1□	
				LS15412KS1□	
				LS15412BS1□	

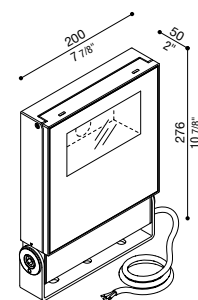

* Complete the CODE □ LED COLOUR 5 | 5700K N | 4000K 3 | 3000K 2 | 2700K 1 | 2200K

Versione on-off: cavo 0,7m H05RN-F. Versione DALI: cavo 0,7m H07RN-F. | On-off version cable: 0,7m H05RN-F. Cable DALI version: 0,7m H07RN-F. | Câble version on-off : 0,7m H05RN-F. Câble version DALI : 0,7m H07RN-F. | Cable versión on-off: 0,7m H05RN-F. Cable versión DALI: 0,7m H07RN-F.

Delta 1 Asimmetrico



IP66 IK 08 5J xx7 CE UK CB	LED			COL.	CODE *
	W	LM MAX.	REAL LM MAX.		
	37	6237	5676	220-240 V	LL15411WA1□
					LL15411GA1□
					LL15411KA1□
					LL15411BA1□
	37	6237	5676	220-240 V DALI	LM15411WA1□
					LM15411GA1□
LM15411KA1□					
LM15411BA1□					
50	7489	6815	220-240 V	LL15412WA1□	
				LL15412GA1□	
				LL15412KA1□	
				LL15412BA1□	
50	7489	6815	220-240 V DALI	LM15412WA1□	
				LM15412GA1□	
				LM15412KA1□	
				LM15412BA1□	
17	3175	2889	220-240 V (☞)	LS15411WA1□	
				LS15411GA1□	
				LS15411KA1□	
				LS15411BA1□	
27	4372	3979	220-240 V (☞)	LS15412WA1□	
				LS15412GA1□	
				LS15412KA1□	
				LS15412BA1□	

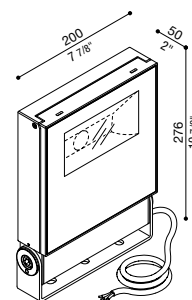

* Complete the CODE □ LED COLOUR 5 | 5700K N | 4000K 3 | 3000K 2 | 2700K 1 | 2200K

Versione on-off: cavo 0,7m H05RN-F. Versione DALI: cavo 0,7m H07RN-F. | On-off version cable: 0,7m H05RN-F. Cable DALI version: 0,7m H07RN-F. | Câble version on-off : 0,7m H05RN-F. Câble version DALI : 0,7m H07RN-F. | Cable versión on-off: 0,7m H05RN-F. Cable versión DALI: 0,7m H07RN-F.

Delta 1 Circular



IP66 IK 08 5J xx7 CE UK	LED			COL.	CODE *
	W	LM	REAL LM		
		MAX.	MAX.		
37	6237	5395	⊕ ⊙ 220-240 V		LL15411WC1□
					LL15411GC1□
					LL15411KC1□
					LL15411BC1□
37	6237	5395	⊕ ⊙ 220-240 V DALI		LM15411WC1□
					LM15411GC1□
					LM15411KC1□
					LM15411BC1□
50	7489	6478	⊕ ⊙ 220-240 V		LL15412WC1□
					LL15412GC1□
					LL15412KC1□
					LL15412BC1□
50	7489	6478	⊕ ⊙ 220-240 V DALI		LM15412WC1□
					LM15412GC1□
					LM15412KC1□
					LM15412BC1□

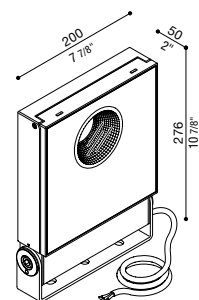

* Complete the CODE □ LED COLOUR 5 | 5700K N | 4000K 3 | 3000K 2 | 2700K 1 | 2200K

Versione on-off: cavo 0,7m H05RN-F. Versione DALI: cavo 0,7m H07RN-F. | On-off version cable: 0,7m H05RN-F. Cable DALI version: 0,7m H07RN-F. | Câble version on-off : 0,7m H05RN-F. Câble version DALI : 0,7m H07RN-F. | Cable versión on-off: 0,7m H05RN-F. Cable versión DALI: 0,7m H07RN-F.



A richiesta, disponibili versioni con vetro colorato: rosso, verde, giallo e bianco.

On request, versions with colored glass available: red, green, yellow and white.

Sur demande, des versions avec verre coloré sont disponibles: rouge, vert, jaune et blanc.

Bajo pedido, versiones de cristal de colores: rojo, verde, amarillo y blanco.

Accessori | Accessories | Accessoires | Accesorios

Ganascia Delta per palo Ø60mm

Non adatto per Delta 3. Non idoneo per installazione su palo Still.

Delta side adapter for post Ø60mm

Not suitable for Delta 3 and for installation on Still posts.

Adaptateur latéral Delta pour poteau Ø60mm

Ne convient pas pour Delta 3 et pour l'installation sur des poteaux Still.

Adaptador lateral Delta para poste Ø60 mm

No apto para Delta 3 ni para instalación en postes Still.

Col.	Code
	LB154000W
	LB154000G
	LB154000K
	LB154000B

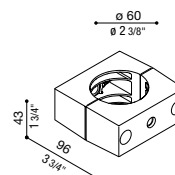

Testapalo Delta 1 per palo Ø60mm

Adatto per l'installazione di un singolo prodotto. Non adatto per pali Still.

Delta 1 post head adapter for Ø60mm pole





Suitable for single product installation. Not suitable for Still poles.

Adaptateur de tête de poteau Delta 1 pour poteau Ø60mm

Convient à l'installation d'un seul produit. Ne convient pas aux poteaux Still.

Adaptador de poste Delta 1 para poste de Ø60mm

Adecuado para la instalación de un solo producto. No apto para postes Still.

Col.	Code
	LB154001W
	LB154001G
	LB154001K
	LB154001B

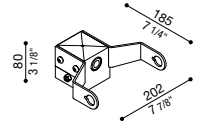

Doppio testapalo Delta 1 per palo Ø60mm

Adatto per l'installazione di due prodotti. Non adatto per pali Still.

Delta 1 double post head adapter for Ø60mm post





Suitable for installation of two products. Not suitable for Still poles.

Adaptateur double tête de poteau Delta 1 pour poteau Ø60mm

Convient pour l'installation de deux produits. Ne convient pas aux poteaux Still.

Adaptador de poste doble Delta 1 para poste de Ø60 mm

Adecuado para la instalación de dos productos. No apto para postes Still.

Col.	Code
	LB154011W
	LB154011G
	LB154011K
	LB154011B

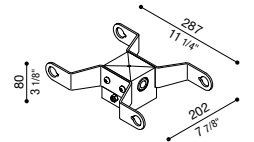



Griglia Delta 1

Grid for Delta 1

Grille pour Delta 1

Rejilla para Delta 1

Col.	Code
	LB154006B
	LB154006Z

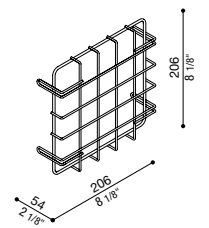

Connettore maschio/femmina 5 poli DALI

Accessorio IP66/IP68 per la connessione di due prodotti in serie DALI. Adatto per cavo ø7/13,5.

5-pin male/female connector DALI

Accessory IP66/IP68 for connecting two products in series DALI. Suitable for ø7/13,5 cable.

Connecteur mâle/femelle à 5 broches DALI

Accessoire IP66/IP68 pour connecter deux produits en série DALI. Convient pour un câble ø7/13,5.

Conector macho/hembra de 5 polos DALI

Accesorio IP66/IP68 para conectar dos productos en serie DALI. Adecuado para cable ø7/13,5.

Col.	Code
	LB156002

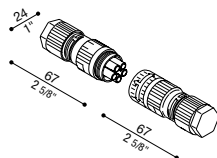

Morsettiera coassiale 3 poli

Morsettiera coassiale a 3 poli, IP68, per cavo ø 7/12 mm.

3-pole coaxial terminal block

3-pole coaxial terminal block, IP68, for cable ø 7/12 mm.

Bornier coaxial à 3 pôles

Bornier coaxial à 3 pôles, IP68, pour câble ø 7/12 mm.

Bloque de terminales coaxiales de 3 polos

Bloque de terminales coaxiales de 3 polos, IP68, para cable ø 7/12 mm.

Col.	Code
	LB11293

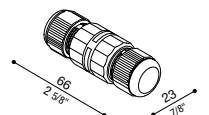



DELTA 1 ASIMMETRICO



DELTA 1 CIRCULAR



DELTA 2 NEW

Installazione

Installation
Installation
Instalación

Terra - Parete - Soffitto

Ground - Wall - Ceiling
Sol - Mur - Plafond
Suelo - Pared - Techo

Materiali

Materials
Materiali
Materiales

Materiale Corpo: Alluminio | Tipo di diffusore: Vetro | Trattamento: Bordo Mare

Material: Aluminium | Diffuser type: Glass | Treatment: Sea Treatment
Matériel du corps: Aluminium | Type de diffuseur: Verre | Traitement: Bord de Mer
Material del cuerpo: Aluminio | Tipo de difusor: Cristal | Tratamiento: Tratamiento marino

Alimentazione

Power supply
Alimentation
Alimentación

220-240 V

Versioni

Versions
Versions
Versiones

DALI



DELTA 2
SIMMETRICO



DELTA 2
ASIMMETRICO



DELTA 2
CIRCULAR



Scopri la gamma
Discover the range
Découvrez la gamme
Descubre la gama

COLOURS



White RAL 9010



Grey High Tech RAL 9006



Corten



Black RAL 9005

Delta 2 Simmetrico



IP66 IK 08 5J xx7 CE UK EN	LED		COL.	CODE *	
	W	LM MAX.			REAL LM MAX.
	72	12.326	11.463	220-240 V	LL15421WS1□
					LL15421GS1□
					LL15421KS1□
					LL15421BS1□
	72	12.326	11.463	220-240 V DALI	LM15421WS1□
					LM15421GS1□
LM15421KS1□					
LM15421BS1□					
97	14.670	13.643	220-240 V	LL15422WS1□	
				LL15422GS1□	
				LL15422KS1□	
				LL15422BS1□	
97	14.670	13.643	220-240 V DALI	LM15422WS1□	
				LM15422GS1□	
				LM15422KS1□	
				LM15422BS1□	
119	17.260	16.052	220-240 V	LL15423WS1□	
				LL15423GS1□	
				LL15423KS1□	
				LL15423BS1□	
119	17.260	16.052	220-240 V DALI	LM15423WS1□	
				LM15423GS1□	
				LM15423KS1□	
				LM15423BS1□	

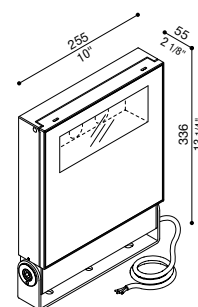

























* Complete the CODE □ LED COLOUR 5 | 5700K N | 4000K 3 | 3000K 2 | 2700K 1 | 2200K

Versione on-off: cavo 0,7m H05RN-F. Versione DALI: cavo 0,7m H07RN-F. | On-off version cable: 0,7m H05RN-F. Cable DALI version: 0,7m H07RN-F. | Câble version on-off : 0,7m H05RN-F. Câble version DALI : 0,7m H07RN-F. | Cable versión on-off: 0,7m H05RN-F. Cable versión DALI: 0,7m H07RN-F.

Delta 2 Asimmetrico

NEW

IP66 IK 08 5J xx7 CE UK CA	LED			COL.	CODE *
	W	LM MAX.	REAL LM MAX.		
●	72	12.326	11.217	⊕ ⊙ 220-240 V	 LL15421WA1□
					 LL15421GA1□
					 LL15421KA1□
					 LL15421BA1□
	72	12.326	11.217	⊕ ⊙ 220-240 V DALI	 LM15421WA1□
					 LM15421GA1□
 LM15421KA1□					
 LM15421BA1□					
97	14.670	13.350	⊕ ⊙ 220-240 V	 LL15422WA1□	
				 LL15422GA1□	
				 LL15422KA1□	
				 LL15422BA1□	
97	14.670	13.350	⊕ ⊙ 220-240 V DALI	 LM15422WA1□	
				 LM15422GA1□	
				 LM15422KA1□	
				 LM15422BA1□	
119	17.260	15.707	⊕ ⊙ 220-240 V	 LL15423WA1□	
				 LL15423GA1□	
				 LL15423KA1□	
				 LL15423BA1□	
119	17.260	15.707	⊕ ⊙ 220-240 V DALI	 LM15423WA1□	
				 LM15423GA1□	
				 LM15423KA1□	
				 LM15423BA1□	

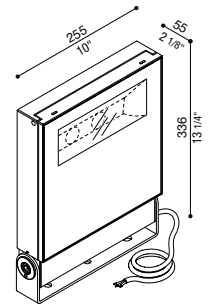

* Complete the CODE □ LED COLOUR 5 | 5700K N | 4000K 3 | 3000K 2 | 2700K 1 | 2200K

Versione on-off: cavo 0,7m H05RN-F. Versione DALI: cavo 0,7m H07RN-F. | On-off version cable: 0,7m H05RN-F. Cable DALI version: 0,7m H07RN-F. | Câble version on-off : 0,7m H05RN-F. Câble version DALI : 0,7m H07RN-F. | Cable versión on-off: 0,7m H05RN-F. Cable versión DALI: 0,7m H07RN-F.

Delta 2 Circular



IP66 IK 08 5J xx7 CE UK ER	LED		REAL LM	COL.	CODE *
	W	LM			
72	12.326	10.662	⊕ ⊙ 220-240 V		LL15421WC1□
					LL15421GC1□
					LL15421KC1□
					LL15421BC1□
72	12.326	10.662	⊕ ⊙ 220-240 V DALI		LM15421WC1□
					LM15421GC1□
					LM15421KC1□
					LM15421BC1□
97	14.670	12.690	⊕ ⊙ 220-240 V		LL15422WC1□
					LL15422GC1□
					LL15422KC1□
					LL15422BC1□
97	14.670	12.690	⊕ ⊙ 220-240 V DALI		LM15422WC1□
					LM15422GC1□
					LM15422KC1□
					LM15422BC1□
119	17.260	14.930	⊕ ⊙ 220-240 V		LL15423WC1□
					LL15423GC1□
					LL15423KC1□
					LL15423BC1□
119	17.260	14.930	⊕ ⊙ 220-240 V DALI		LM15423WC1□
					LM15423GC1□
					LM15423KC1□
					LM15423BC1□

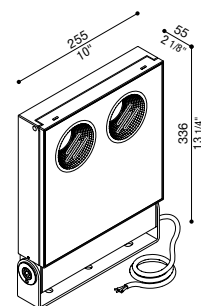

* Complete the CODE □ LED COLOUR 5 | 5700K N | 4000K 3 | 3000K 2 | 2700K 1 | 2200K

Versione on-off: cavo 0,7m H05RN-F. Versione DALI: cavo 0,7m H07RN-F. | On-off version cable: 0,7m H05RN-F. Cable DALI version: 0,7m H07RN-F. | Câble version on-off : 0,7m H05RN-F. Câble version DALI : 0,7m H07RN-F. | Cable versión on-off: 0,7m H05RN-F. Cable versión DALI: 0,7m H07RN-F.



A richiesta, disponibili versioni con vetro colorato: rosso, verde, giallo e bianco.

On request, versions with colored glass available: red, green, yellow and white.

Sur demande, des versions avec verre coloré sont disponibles: rouge, vert, jaune et blanc.

Bajo pedido, versiones de cristal de colores: rojo, verde, amarillo y blanco.

Ganascia Delta per palo Ø60mm

Non adatto per Delta 3. Non idoneo per installazione su palo Still.

Delta side adapter for post Ø60mm





Not suitable for Delta 3 and for installation on Still posts.

Adaptateur latéral Delta pour poteau Ø60mm

Ne convient pas pour Delta 3 et pour l'installation sur des poteaux Still.

Adaptador lateral Delta para poste Ø60 mm

No apto para Delta 3 ni para instalación en postes Still.

Col.	Code
	LB154000W
	LB154000G
	LB154000K
	LB154000B

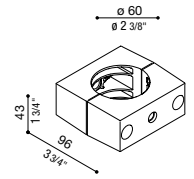

Testapalo Delta 2 per palo Ø60mm

Adatto per l'installazione di un singolo prodotto. Non adatto per pali Still.

Delta 2 post head adapter for Ø60mm pole





Suitable for single product installation. Not suitable for Still poles.

Adaptateur de tête de poteau Delta 2 pour poteau Ø60mm

Convient à l'installation d'un seul produit. Ne convient pas aux poteaux Still.

Adaptador de poste Delta 2 para poste de Ø60mm

Adecuado para la instalación de un solo producto. No apto para postes Still.

Col.	Code
	LB154002W
	LB154002G
	LB154002K
	LB154002B

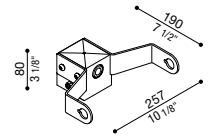

Doppio testapalo Delta 2 per palo Ø60mm

Adatto per l'installazione di due prodotti. Non adatto per pali Still.

Delta 2 double post head adapter for Ø60mm post





Suitable for installation of two products. Not suitable for Still poles.

Adaptateur double tête de poteau Delta 2 pour poteau Ø60mm

Convient pour l'installation de deux produits. Ne convient pas aux poteaux Still.

Adaptador de poste doble Delta 2 para poste de Ø60 mm

Adecuado para la instalación de dos productos. No apto para postes Still.

Col.	Code
	LB154012W
	LB154012G
	LB154012K
	LB154012B

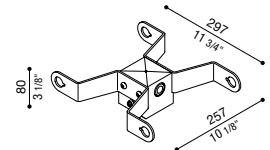



Griglia Delta 2

Grid for Delta 2

Grille pour Delta 2

Rejilla para Delta 2

Griglia Delta 2	
Col.	Code
	LB154007B
	LB154007Z

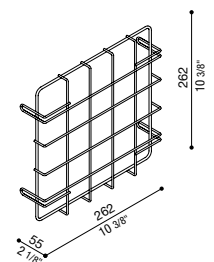

Connettore maschio/femmina 5 poli DALI

Accessorio IP66/IP68 per la connessione di due prodotti in serie DALI. Adatto per cavo $\varnothing 7/13,5$.

5-pin male/female connector DALI

Accessory IP66/IP68 for connecting two products in series DALI. Suitable for $\varnothing 7/13,5$ cable.

Connecteur mâle/femelle à 5 broches DALI

Accessoire IP66/IP68 pour connecter deux produits en série DALI. Convient pour un câble $\varnothing 7/13,5$.

Conector macho/hembra de 5 polos DALI

Accesorio IP66/IP68 para conectar dos productos en serie DALI. Adecuado para cable $\varnothing 7/13,5$.

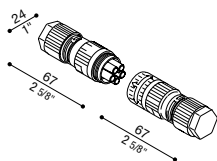

Col.	Code
	LB156002

Morsettiera coassiale 3 poli

Morsettiera coassiale a 3 poli, IP68, per cavo $\varnothing 7/12$ mm.

3-pole coaxial terminal block

3-pole coaxial terminal block, IP68, for cable $\varnothing 7/12$ mm.

Bornier coaxial à 3 pôles

Bornier coaxial à 3 pôles, IP68, pour câble $\varnothing 7/12$ mm.

Bloque de terminales coaxiales de 3 polos

Bloque de terminales coaxiales de 3 polos, IP68, para cable $\varnothing 7/12$ mm.

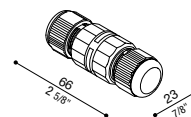

Col.	Code
	LB11293



Griglia per Delta 2.
Grid for Delta 2.
Grille pour Delta 2.
Rejilla para Delta 2.



DELTA 2 ASIMMETRICO



DELTA 2 CIRCULAR





DELTA 2 CIRCULAR



DELTA 2 SIMMETRICO

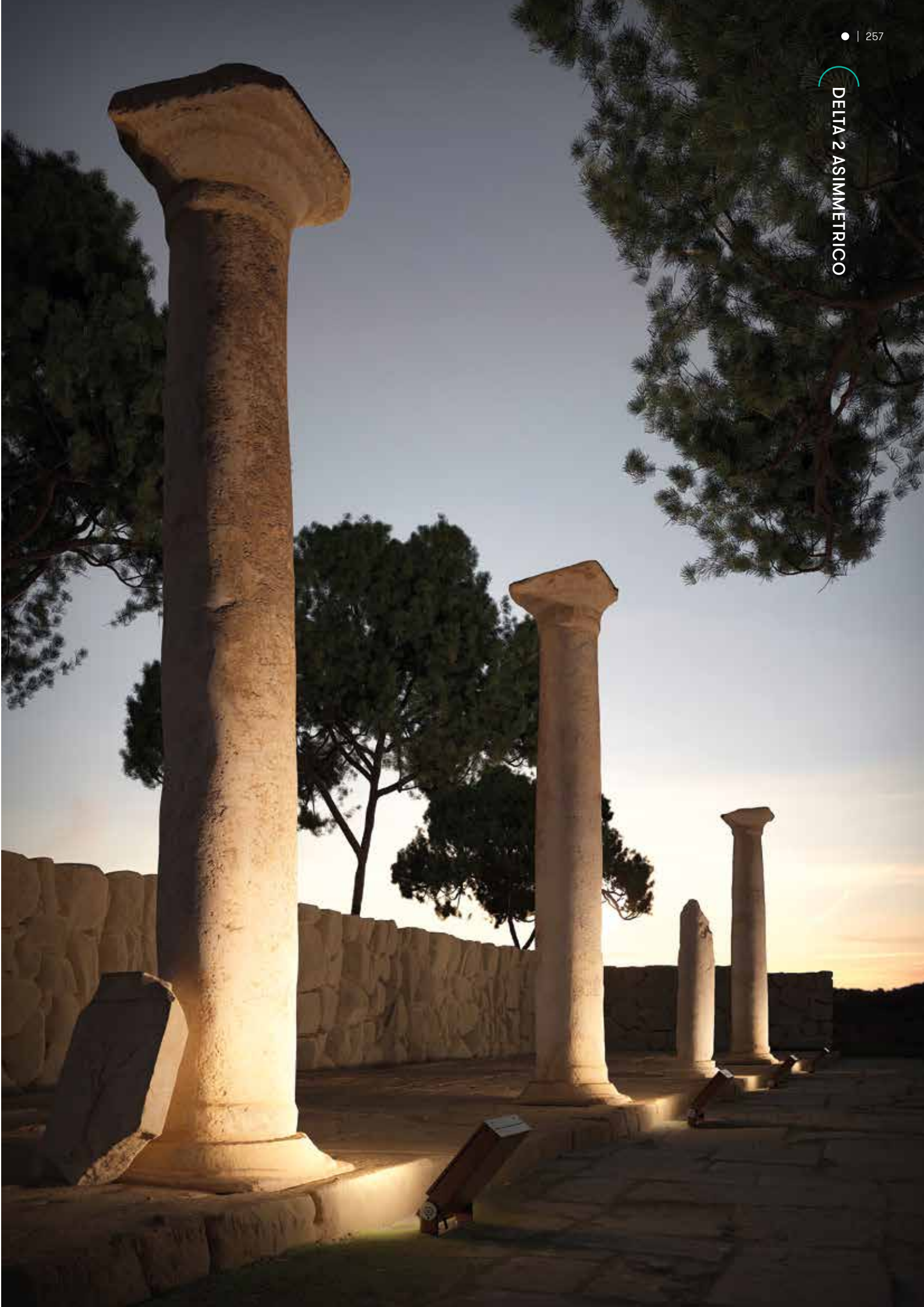

DELTA 3 NEW

Installazione

Installation
Installation
Instalación

Terra - Parete - Soffitto

Ground - Wall - Ceiling
Sol - Mur - Plafond
Suelo - Pared - Techo

Materiali

Materials
Materiali
Materiales

Materiale Corpo: Alluminio | Tipo di diffusore: Vetro | Trattamento: Bordo Mare

Material: Aluminium | Diffuser type: Glass | Treatment: Sea Treatment
Matériel du corps: Aluminium | Type de diffuseur: Verre | Traitement: Bord de Mer
Material del cuerpo: Aluminio | Tipo de difusor: Cristal | Tratamiento: Tratamiento marino

Alimentazione

Power supply
Alimentation
Alimentación

220-240 V

Versioni

Versions
Versions
Versiones

DALI



DELTA 3
SIMMETRICO



DELTA 3
ASIMMETRICO



DELTA 3
CIRCULAR



Scopri la gamma
Discover the range
Découvrez la gamme
Descubre la gama

COLOURS



White RAL 9010



Grey High Tech RAL 9006



Corten



Black RAL 9005

Delta 3 Simmetrico



IP66 IK 08 5J xx7 CE UK ER	LED			COL.	CODE *
	W	LM MAX.	REAL LM MAX.		
	133	20.787	19.332	220-240 V	LL15431WS1□
					LL15431GS1□
					LL15431KS1□
					LL15431BS1□
	133	20.787	19.332	220-240 V DALI	LM15431WS1□
					LM15431GS1□
					LM15431KS1□
					LM15431BS1□
	155	23.479	21.835	220-240 V	LL15432WS1□
					LL15432GS1□
					LL15432KS1□
					LL15432BS1□
155	23.479	21.835	220-240 V DALI	LM15432WS1□	
				LM15432GS1□	
				LM15432KS1□	
				LM15432BS1□	
196	27.799	25.853	220-240 V	LL15433WS1□	
				LL15433GS1□	
				LL15433KS1□	
				LL15433BS1□	
196	27.799	25.853	220-240 V DALI	LM15433WS1□	
				LM15433GS1□	
				LM15433KS1□	
				LM15433BS1□	

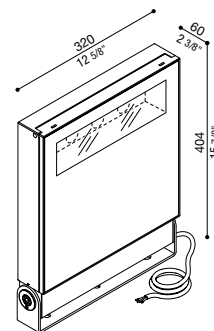

* Complete the CODE □ LED COLOUR 5 | 5700K N | 4000K 3 | 3000K 2 | 2700K 1 | 2200K

Versione on-off: cavo 0,7m H05RN-F. Versione DALI: cavo 0,7m H07RN-F. | On-off version cable: 0,7m H05RN-F. Cable DALI version: 0,7m H07RN-F. | Câble version on-off : 0,7m H05RN-F. Câble version DALI : 0,7m H07RN-F. | Cable versión on-off: 0,7m H05RN-F. Cable versión DALI: 0,7m H07RN-F.

Delta 3 Asimmetrico



IP66 IK 08 5J xx7 CE UK EBC	LED			COL.	CODE *
	W	LM MAX.	REAL LM MAX.		
	133	20.787	18.916	220-240 V	LL15431WA1□
					LL15431GA1□
					LL15431KA1□
					LL15431BA1□
	133	20.787	18.916	220-240 V DALI	LM15431WA1□
					LM15431GA1□
LM15431KA1□					
LM15431BA1□					
155	23.479	21.366	220-240 V	LL15432WA1□	
				LL15432GA1□	
				LL15432KA1□	
				LL15432BA1□	
155	23.479	21.366	220-240 V DALI	LM15432WA1□	
				LM15432GA1□	
				LM15432KA1□	
				LM15432BA1□	
196	27.799	25.297	220-240 V	LL15433WA1□	
				LL15433GA1□	
				LL15433KA1□	
				LL15433BA1□	
196	27.799	25.297	220-240 V DALI	LM15433WA1□	
				LM15433GA1□	
				LM15433KA1□	
				LM15433BA1□	

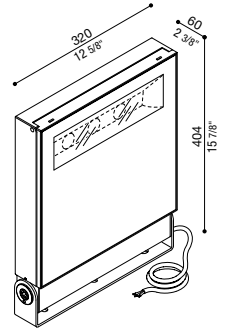

* Complete the CODE □ LED COLOUR 5 | 5700K N | 4000K 3 | 3000K 2 | 2700K 1 | 2200K

Versione on-off: cavo 0,7m H05RN-F. Versione DALI: cavo 0,7m H07RN-F. | On-off version cable: 0,7m H05RN-F. Cable DALI version: 0,7m H07RN-F. | Câble version on-off : 0,7m H05RN-F. Câble version DALI : 0,7m H07RN-F. | Cable versión on-off: 0,7m H05RN-F. Cable versión DALI: 0,7m H07RN-F.

Delta 3 Circular



IP66 IK 08 5J xx7 CE UK EBC	LED			COL.	CODE *					
	W	LM MAX.	REAL LM MAX.							
	133	20.787	17.981	220-240 V	LL15431WC1□					
					LL15431GC1□					
					LL15431KC1□					
					LL15431BC1□					
					LM15431WC1□					
					LM15431GC1□					
	133	20.787	17.981	220-240 V DALI	LM15431WC1□					
					LM15431GC1□					
					LM15431KC1□					
					LM15431BC1□					
						155	23.479	20.309	220-240 V	LL15432WC1□
										LL15432GC1□
LL15432KC1□										
LL15432BC1□										
	155	23.479	20.309	220-240 V DALI						LM15432WC1□
										LM15432GC1□
					LM15432KC1□					
					LM15432BC1□					
						196	27.799	24.046	220-240 V	LL15433WC1□
										LL15433GC1□
LL15433KC1□										
LL15433BC1□										
	196	27.799	24.046	220-240 V DALI						LM15433WC1□
										LM15433GC1□
					LM15433KC1□					
					LM15433BC1□					

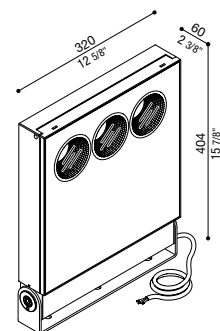

* Complete the CODE □ LED COLOUR 5 | 5700K N | 4000K 3 | 3000K 2 | 2700K 1 | 2200K

Versione on-off: cavo 0,7m H05RN-F. Versione DALI: cavo 0,7m H07RN-F. | On-off version cable: 0,7m H05RN-F. Cable DALI version: 0,7m H07RN-F. | Câble version on-off : 0,7m H05RN-F. Câble version DALI : 0,7m H07RN-F. | Cable versión on-off: 0,7m H05RN-F. Cable versión DALI: 0,7m H07RN-F.



A richiesta, disponibili versioni con vetro colorato: rosso, verde, giallo e bianco.

On request, versions with colored glass available: red, green, yellow and white.

Sur demande, des versions avec verre coloré sont disponibles: rouge, vert, jaune et blanc.

Bajo pedido, versiones de cristal de colores: rojo, verde, amarillo y blanco.

Testapalo Delta 3 per palo Ø60mm

Adatto per l'installazione di un singolo prodotto. Non adatto per pali Still.

Testapalo Delta 3 per palo Ø60mm





Suitable for single product installation. Not suitable for Still poles.

Adaptateur de tête de poteau Delta 3 pour poteau Ø60mm

Convient à l'installation d'un seul produit. Ne convient pas aux poteaux Still.

Adaptador de poste Delta 3 para poste de Ø60mm

Adecuado para la instalación de un solo producto. No apto para postes Still.

Col.	Code
	LB154003W
	LB154003g
	LB154003K
	LB154003B

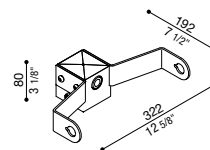

Doppio testapalo Delta 3 per palo Ø60mm

Adatto per l'installazione di un due prodotti. Non adatto per pali Still.

Delta 3 double post head adapter for Ø60mm post





Suitable for installation of two products. Not suitable for Still poles.

Adaptateur double tête de poteau Delta 3 pour poteau Ø60mm

Convient pour l'installation de deux produits. Ne convient pas aux poteaux Still.

Adaptador de poste doble Delta 3 para poste de Ø60 mm

Adecuado para la instalación de dos productos. No apto para postes Still.

Col.	Code
	LB154013W
	LB154013G
	LB154013K
	LB154013B

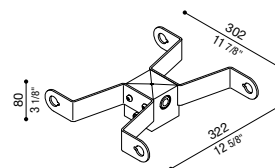



Griglia Delta 3

Grid for Delta 3

Grille pour Delta 3

Rejilla para Delta 3

Col.	Code
	LB154008B
	LB154008Z

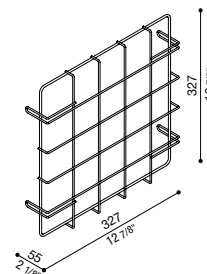

Connettore maschio/femmina 5 poli DALI

Accessorio IP66/IP68 per la connessione di due prodotti in serie DALI. Adatto per cavo ø7/13,5.

5-pin male/female connector DALI

Accessory IP66/IP68 for connecting two products in series DALI. Suitable for ø7/13,5 cable.

Connecteur mâle/femelle à 5 broches DALI

Accessoire IP66/IP68 pour connecter deux produits en série DALI. Convient pour un câble ø7/13,5.

Conector macho/hembra de 5 polos DALI

Accesorio IP66/IP68 para conectar dos productos en serie DALI. Adecuado para cable ø7/13,5.

Col.	Code
	LB156002

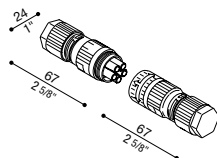

Morsettiera coassiale 3 poli

Morsettiera coassiale a 3 poli, IP68, per cavo ø 7/12 mm.

3-pole coaxial terminal block

3-pole coaxial terminal block, IP68, for cable ø 7/12 mm.

Bornier coaxial à 3 pôles

Bornier coaxial à 3 pôles, IP68, pour câble ø 7/12 mm.

Bloque de terminales coaxiales de 3 polos

Bloque de terminales coaxiales de 3 polos, IP68, para cable ø 7/12 mm.

Col.	Code
	LB11293

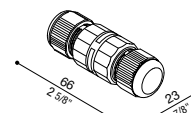

DELTA 3 ASIMMETRICO

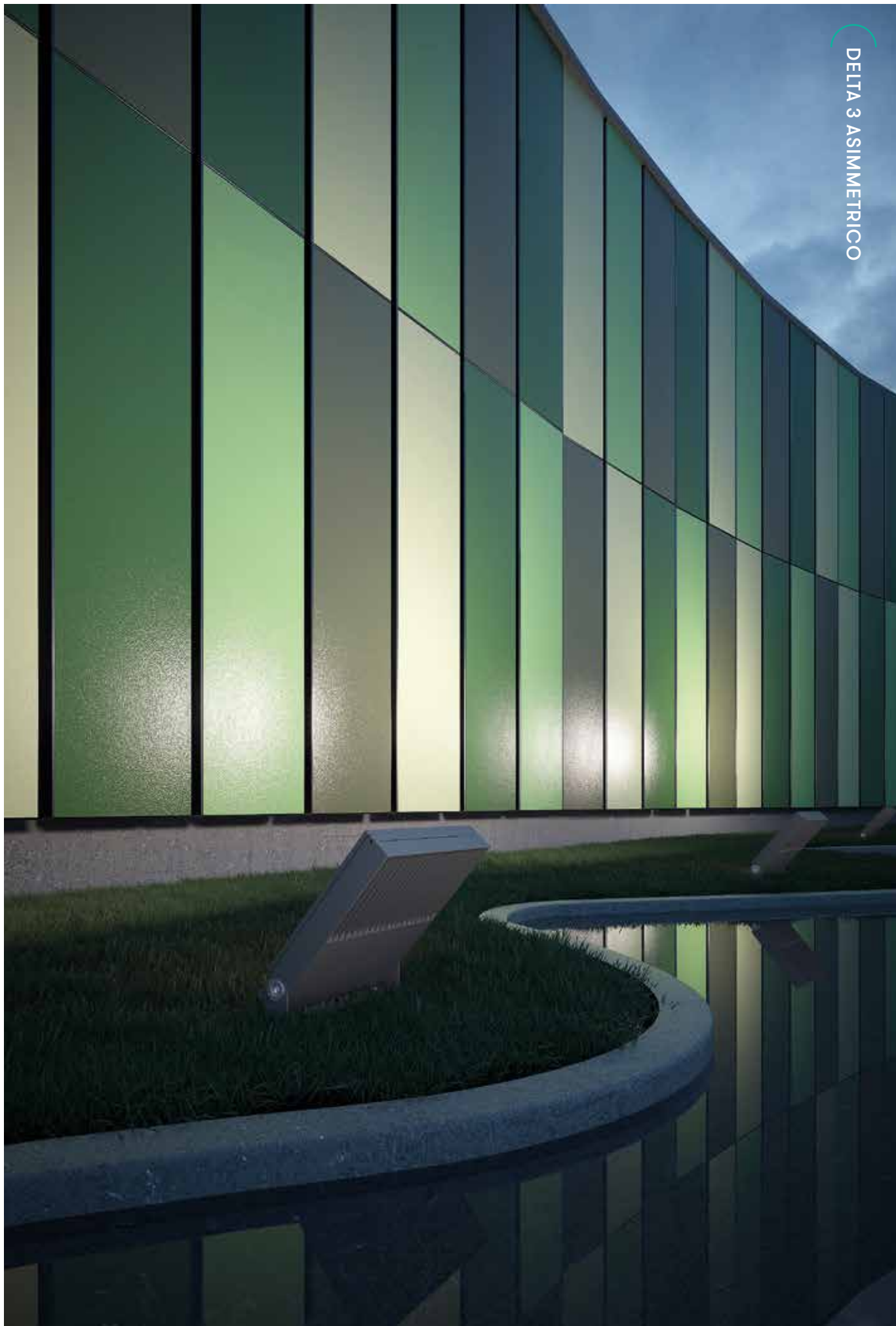

DELTA 3 ASIMMETRICO + GRIGLIA



Famiglia Delta.
Delta family.
Famille Delta.
Familia Delta.





FEATURES

Fasci luminosi
Light beams
Faisceaux lumineux
Haces luminosas

LUX

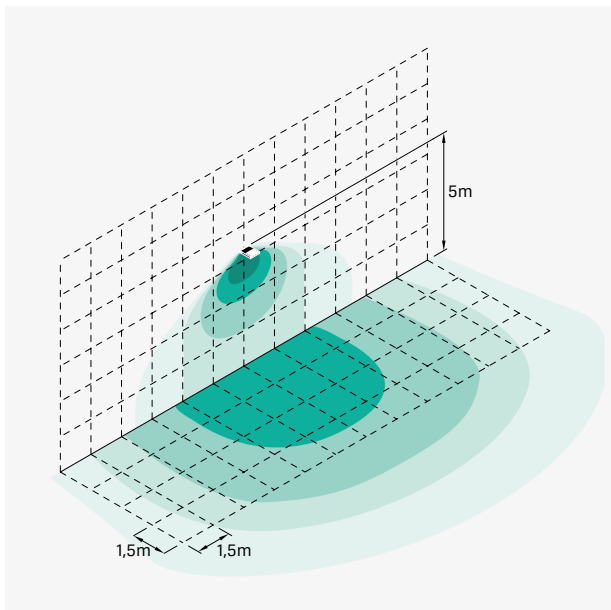
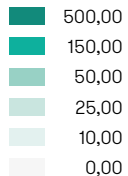

A1 ASIMMETRICO DELTA 3 196W

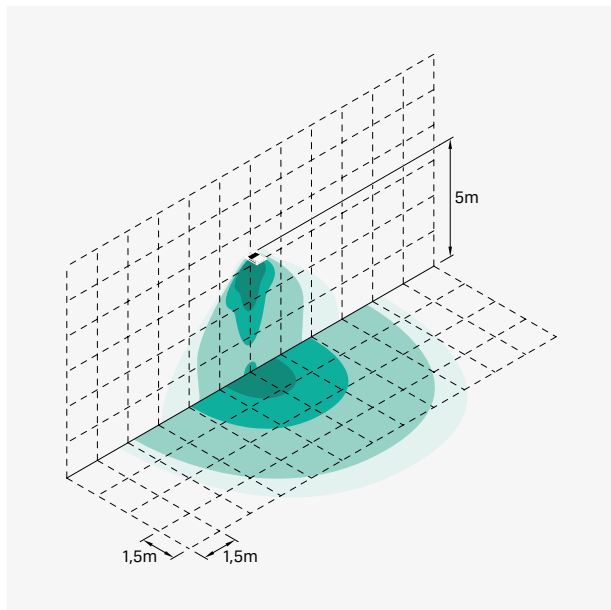

C1 CIRCULAR DELTA 3 196W

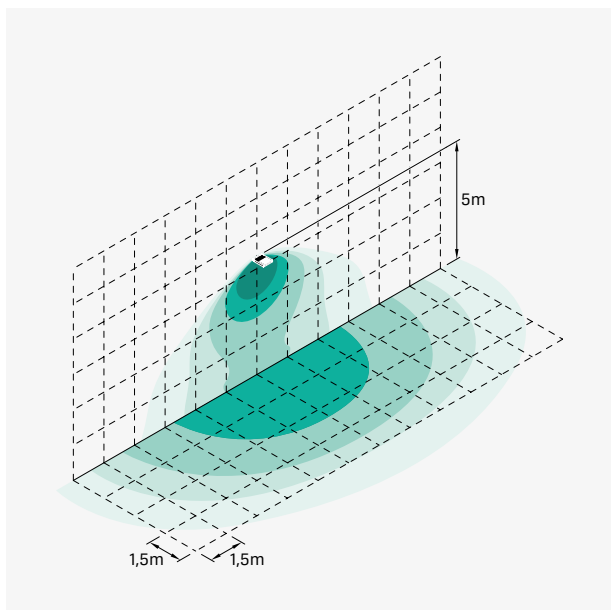

S1 SIMMETRICO DELTA 3 196W



FEATURES

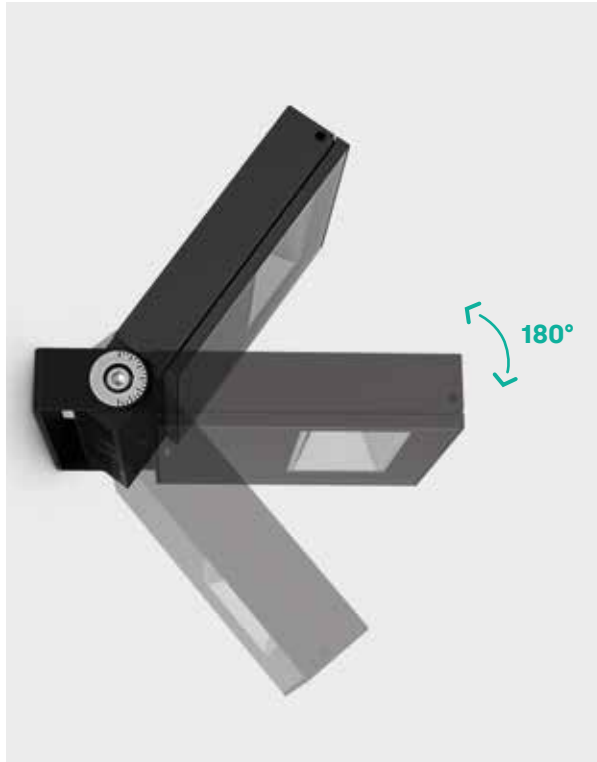

- 
Rotazione di 180°.
 180° rotation.
 Rotation à 180°.
 Rotación de 180°.



- 
Apertura proiettore per cablaggio e ispezione.
 Projector opening for wiring and inspection.
 Ouverture du projecteur pour le câblage et l'inspection.
 Abertura del faro para el cableado y la inspección.

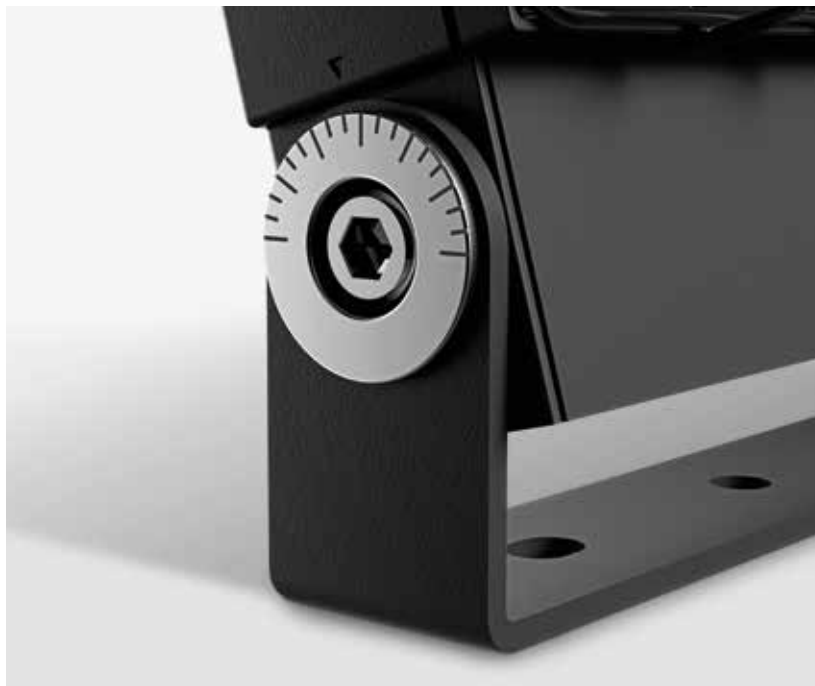

- 
Vite regolabile con scala graduata.
 Adjustable screw with graduated scale.
 Vis réglable avec graduation.
 Tornillo regulable con escala.

