

Art 100 Top

LL1160023

Lombardo.

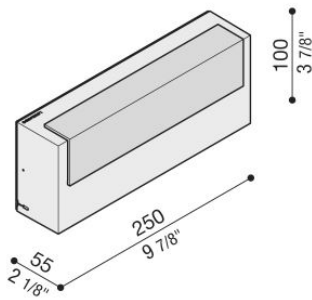

Informazioni tecniche:

Installazione:	Parete
Finitura:	Nero da stampaggio
Tipo di diffusore:	Polycarbonato
Tipo lampada:	LED
Classe energetica:	F
Temperatura colore:	3000K
CRI:	>80
LB Factor:	L80B20 - 50.000h
Rischio fotobiologico:	RG0
Potenza assorbita Watt:	10
Lumen:	1100
Real Lumen:	484
Alimentazione:	☑️ integrata
LED:	220-240 V
Interruttore magnetotermico	64-80-90-100
B10 - C10 - B16 - C16	
Classe di isolamento:	☐ CL.II
Grado di protezione:	IP 66
Resistenza alla rottura:	IK 10 20J xx9
Marchi di Conformità:	CE UK

Cover in polycarbonato.



Art 100 Top

LL1160023

Lombardo.



Art 100 Top

LL1160023

Lombardo.

Simulazioni illuminotecniche:

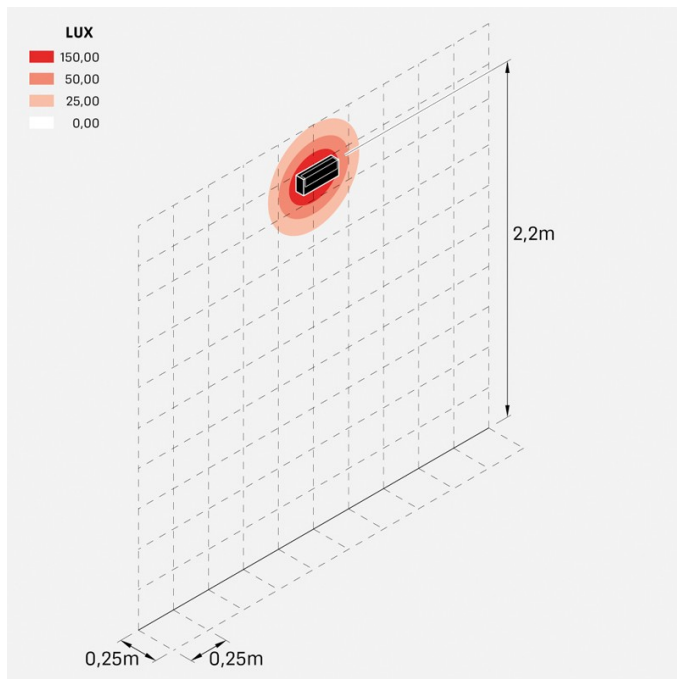

art_100_top