



PIN



- Pin T
- Pin T Asimmetrico
- Pin Q
- Pin Q Asimmetrico

PIN

Installazione

Installation
Installation
Instalación

Incasso parete - Incasso soffitto

Wall recess - Ceiling recess
Encastrement au mur - Encastrement au plafond
Empotrar pared - Empotrar techo

Materiali

Materials
Materiali
Materiales

Materiale Corpo: Alluminio | Tipo di diffusore: Vetro serigrafato | Trattamento: Bordo Mare

Material: Aluminium | Diffuser type: Serigraphed glass | Treatment: Sea Treatment
Matériel du corps: Aluminium | Type de diffuseur: Verre sérigraphié | Traitement: Bord de Mer
Material del cuerpo: Aluminio | Tipo de difusor: Vidro serigrafado | Tratamiento: Tratamiento marino

Alimentazione

Power supply
Alimentation
Alimentación

AC DIRECT

Versioni

Versions
Versions
Versiones

Taglio di fase | Cavo Alimentazione: 0,20 metri H05RN-F

Phase cut | Power cable: 0.20 metri H05RN-F
Coupure de phase | Câble d'alimentation: 0,20 metri H05RN-F
Corte de fase | Cable de alimentación: 0,20 metri H05RN-F



PIN
T



PIN
T ASIMMETRICO



PIN
Q



PIN
Q ASIMMETRICO



COLOURS



Black serigraphy



Grey High Tech Serigraphy



Corten serigraphy



Neutral

Pin T

IP66 IK 07 2J xx5 CE UK CB	LED			COL.	CODE *	
	W	LM	REAL LM			
	2	200	56	☉ ☑ AC DIRECT	LL125000 <input type="checkbox"/>	
					LL125001 <input type="checkbox"/>	
					LL125002 <input type="checkbox"/>	
	2	200	56	☉ ☑ AC DIRECT KIT BOX	LL125100 <input type="checkbox"/>	
					LL125101 <input type="checkbox"/>	
					LL125102 <input type="checkbox"/>	
LL125103 <input type="checkbox"/>						

* Complete the CODE LED COLOUR N | 4000K 3 | 3000K 2 | 2700K

Codici LL12510: KIT composto da Pin T + armatura da incasso 502 LB1250001. | Codes LL12510: Kit consisting of Pin T + recess box 502 LB1250001. | Codes LL12510: Kit composé des Pin T + armature à encastrer 502 LB1250001. | Códigos LL12510: Kit compuesto por Pin T + LB1250001.

Pin T Asimmetrico

IP66 IK 07 2J xx5 CE UK CB	LED			COL.	CODE *	
	W	LM	REAL LM			
	2	200	67	☉ ☑ AC DIRECT	LL125004 <input type="checkbox"/>	
					LL125005 <input type="checkbox"/>	
					LL125006 <input type="checkbox"/>	
	2	200	67	☉ ☑ AC DIRECT KIT BOX	LL125104 <input type="checkbox"/>	
					LL125105 <input type="checkbox"/>	
					LL125106 <input type="checkbox"/>	
LL125107 <input type="checkbox"/>						

* Complete the CODE LED COLOUR N | 4000K 3 | 3000K 2 | 2700K

Deflettore in alluminio. Codici LL12510: KIT composto da Pin T Asimmetrico + armatura da incasso 502 LB1250001. | Deflector made of aluminum. Codes LL12510: Kit consisting of Pin T Asimmetrico+ recess box 502 LB1250001. | Réflecteur en aluminium. Codes LL12510: Kit composé des Pin T Asimmetrico + armature à encastrer 502 LB1250001. | Reflector de aluminio. Códigos LL12510: Kit compuesto por Pin T Asimmetrico + LB1250001.













Pin Q

IP66 IK 07 2J xx5 CE UK CB	LED			COL.	CODE *	
	W	LM	REAL LM			
	2	200	56	☉ ☑ AC DIRECT	LL125008 <input type="checkbox"/>	
					LL125009 <input type="checkbox"/>	
					LL125010 <input type="checkbox"/>	
	2	200	56	☉ ☑ AC DIRECT KIT BOX	LL125108 <input type="checkbox"/>	
					LL125109 <input type="checkbox"/>	
					LL125110 <input type="checkbox"/>	
LL125111 <input type="checkbox"/>						

* Complete the CODE LED COLOUR N | 4000K 3 | 3000K 2 | 2700K

Codici LL12510, LL12511: KIT composto da Pin Q + armatura da incasso 502 LB1250001. | Codes LL12510, LL12511: Kit consisting of Pin Q + recess box 502 LB1250001. | Codes LL12510, LL12511: Kit composé des Pin Q + armature à encastrer 502 LB1250001. | Códigos LL12510, LL12511: Kit compuesto por Pin Q + LB1250001.

Pin Q Asimmetrico

IP66 IK 07 2J xx5 CE UK ER	LED			COL.	CODE *
	W	LM	REAL LM		
	2	200	67	  AC DIRECT	 LL125012□
					 LL125013□
					 LL125014□
					 LL125015□
	2	200	67	  AC DIRECT  KIT BOX	 LL125112□
					 LL125113□
					 LL125114□
					 LL125115□

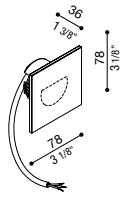

* Complete the CODE □ LED COLOUR N | 4000K 3 | 3000K 2 | 2700K

Deflettore in alluminio. Codici LL12511: KIT composto da Pin Q Asimmetrico + armatura da incasso 502 LB1250001. | Deflector made of aluminum. Codes LL12511: Kit consisting of Pin Q Asimmetrico + recess box 502 LB1250001. | Réflecteur en aluminium. Codes LL12510, LL12511: Kit composé des Pin Q Asimmetrico + armature à encastrer 502 LB1250001. | Reflector de aluminio. Códigos LL12511: Kit compuesto por Pin Q Asimmetrico + LB1250001.

Accessori | Accessories | Accessoires | Accesorios

Scatola incasso standard 502

Recess Box 502

Col. Code

Armature à encastrer standard 502

LB1250001

Caja de empotrar standard 502

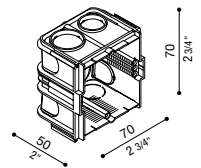

Scatola incasso standard cartongesso 502

Se utilizzata per l'installazione di PIN, il prodotto risulterà staccato dalla parete di circa 2mm.

Col. Code

Recess Plasterboard wall Box 502

LB11693

If used for PIN installation, the product will be detached from the wall by approximately 2mm.

Armature à encastrer placoplâtre 502

Si'il est utilisé pour une installation PIN, le produit se détachera du mur d'environ 2 mm.

Caja de empotrar estándar 502 para cartón yeso

Si se utiliza para la instalación con PIN, el producto se despegará de la pared aproximadamente 2 mm.

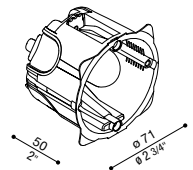

Bus DALI

Varialuce universale comandabile con segnale DALI. Dimmerazione a Taglio di Fase discendente (a fine fase) IGBT Trailing-Edge.

Col. Code

Bus DALI

Universal dimmer controlled by DALI signal. Descending Phase Cutting dimming (at the end of the phase) IGBT Trailing-Edge.

LB1070110

Bus DALI

Variateur universel commandé par un signal DALI. Phase descendante Gradation par coupure (à la fin de la phase) IGBT Trailing-Edge.

Bus DALI

Dimmer universal controlado por señal DALI. Atenuación por corte de fase descendente (al final de la fase) IGBT Trailing-Edge.

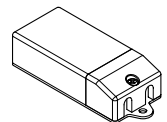



FEATURES



Disponibile online download della dima per la ghiera di fissaggio.

Available online template for fixing retaining ring.

Disponibile online gabarit pour bague de fixation.

Descarga online la plantilla para fijar en anillo.

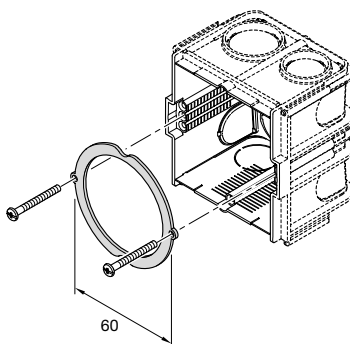

Possibile scelta di 3 differenti serigrafie colorate: nero - grigio HT - Corten.

Possible choice of serigraphed glass in 3 different colours: black - HT grey - Corten.

Possibilité de choisir entre 3 sérigraphies colorées différentes : noir - gris HT - corten.

Posibilidad de elegir entre 3 serigrafías de colores diferentes: negro, gris HT y corten.



PIN ◊ ASIMMETRICO





PIN T

