

Tag 110/210 junction box

LB1150009

Lombardo.

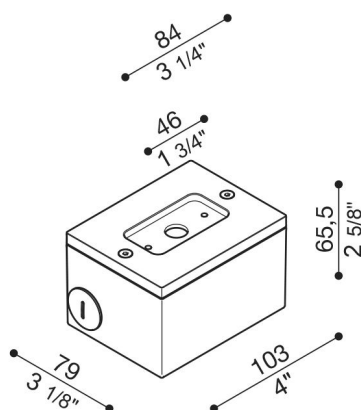
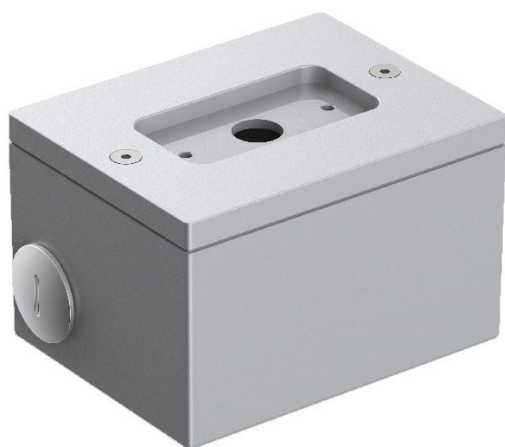

Generality

Installation:	Wall
Producer:	Lombardo S.r.l.
Code:	LB1150009
Pieces per package:	1

Characteristic

Associated products:	Tag 210 White, Tag 210 Power, Tag 110, Tag 210, Tag 210 Asimmetrico, Tag 110 White
----------------------	--

Standards and Marks of Conformity:	CE UK ER
------------------------------------	-------------

Product description:

Electrical junction box for fitting Tag 110/210 so that it projects from the wall (not flush fitting). Body made of die-cast aluminium for fast connection to the rigid 20 mm. pipe. Highly resistant to oxidization thanks to the zirconium based passivation process and the coating with UV-stabilised polyester resins. A4 stainless steel nuts and bolts.