

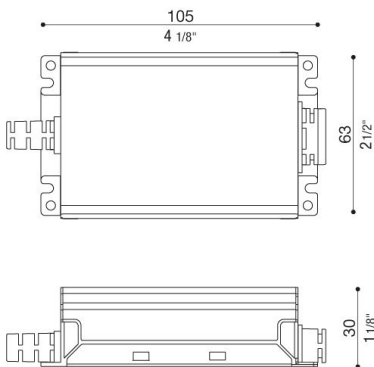

Technical information:

Brand	MEANWELL
Reference number	XLG-25
IP	67
Power output	25W
Nominal DC output voltage (under load)	22-54V
Nominal output current	600mA
Input voltage range	90-305V
Frequency	47/63Hz
Power factor (λ)	0,95
Circuit breaker	3 - 5 - 5 - 8
Specifications	On-Off

Dimension



LED Controlgear Constant Current

Series connection

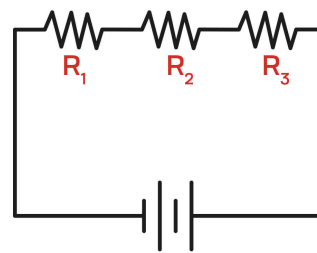

Warning!!!

Before connecting the ballast to the mains, ensure that the LEDs on the secondary are connected. Otherwise the lamp may not switch on.

